

Specifications: Model VT-313(60) NPT Valve

Vertical - Top In Flow

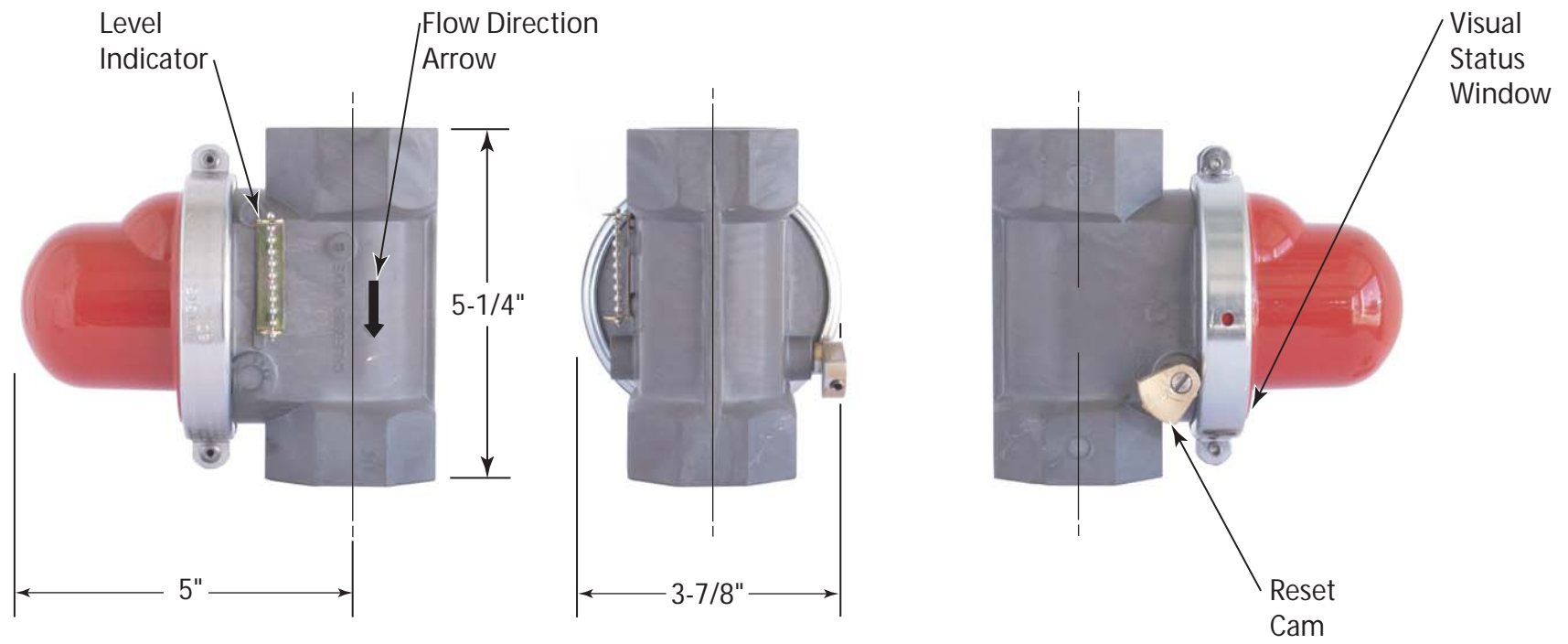

Valve Model#	CA-DSA No.	Length	Height	Width	Nominal Pipe Size	Threads Per Inch	APPLICATION	DATA
							Max. Pressure	Fuel
VT-313	60-04	5"	5-1/4"	3-7/8"	1-1/2"	11-1/2	60 psi	Dry Fuel Gas

